

# Ceiling Mounted Menu Board Systems

## Custom Configured for Your Project

for 32" - 75"+ displays

### Easy to Quote-Easy to Order

Priced per display makes it easy to specify to customer. Mustang provides a custom installation drawing for each configuration ordered.

### Landscape or Portrait Orientation

Displays can be installed in either landscape or portrait orientation and accomodates all VESA patterns through 800x600mm.

### Single Side or Back to Back Configuration

Choose from single side in-line, or back to back configuration.

### Infinitely Expandable-Easy to Install and Align

Whether installing 2 displays or 20, installation and alignment is a breeze. Integrated tilt, horizontal, vertical and roll adjustments at each display.

### Choice of Ceiling Adapter

Includes heavy duty ceiling interface adapter(s) specific to your installation. Add fixed or adjustable columns (MPE-Series or MPEA-Series) to complete the solution.



\*extension pipes sold separately or provided by customer

## Per Display Configurations



### MPCM-M22V

Single side landscape or portrait configuration with 200mm x 200mm VESA adapter. (150 lb per display).



### MPCM-DM22V

Back to back landscape or portrait configuration with 200mm x 200mm VESA adapter. (150 lb per display).



### MPCM-L44V

Single side landscape or portrait configuration with VESA adapter through 400mm x 400mm. (150 lb per display).

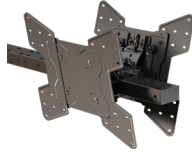

### MPCM-DL44V

Back to back landscape or portrait configuration with VESA adapter through 400mm x 400mm. (150 lb per display).

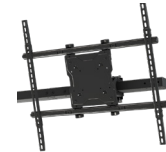

### MPCM-X86U

Single side landscape or portrait configuration with universal adapter through 800mm x 600mm. (150 lb per display).

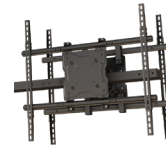

### MPCM-DX86U

Back to back landscape or portrait configuration with universal adapter through 800mm x 600mm. (150 lb per display).

## Single-Pole Kits

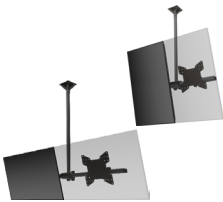

### MPCM-2KM44V

(2 displays, single side)

Single pole system for 2 in-line displays in either landscape or portrait orientation with VESA interface up to 400mm x 400mm. (150 lb per display).

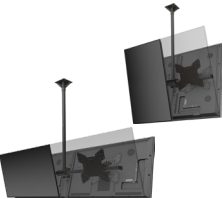

### MPCM-D2KM44V

(4 displays, 2 in-line, back to back)

Single pole system for 2 in-line displays back to back, in either landscape or portrait orientation with VESA interface up to 400mm x 400mm. (125 lb per display).

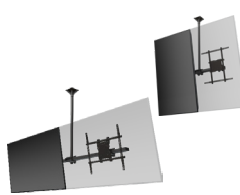

### MPCM-2KX86U

(2 displays, single side)

Single pole system for 2 in-line displays in either landscape or portrait orientation with universal adapter through 800mm x 600mm. (150 lb per display).

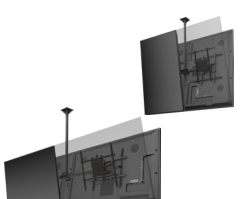

### MPCM-D2KX86U

(4 displays, 2 in-line, back to back)

Single pole system for 2 in-line displays back to back, in either landscape or portrait orientation with universal adapter through 800mm x 600mm. (125 lb per display).

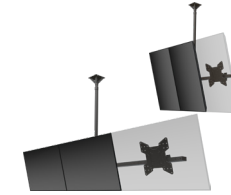

### MPCM-3KL44V

(3 displays, single side)

Single pole system for 3 in-line displays in either landscape or portrait orientation with VESA interface up to 400mm x 400mm. (150 lb per display).

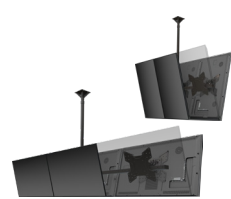

### MPCM-D3KL44V

(6 displays, 3 in-line, back to back)

Single pole system for 3 in-line displays back to back, in either landscape or portrait orientation with VESA interface up to 400mm x 400mm. (80 lb per display).

## Ceiling Adapters

### Heavy Duty Structural Adapter

Attaches directly to Unistrut or any other structural surfaces.



### Heavy Duty Truss Adapter

Attaches to truss up to 3.5" in diameter.



### Cathedral Ceiling Adapter

Attaches to vaulted ceiling joists (cathedral ceilings).

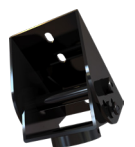

# Ceiling Mounted Menu Board Systems

## Custom Configured for Your Project

Mustang AV  
www.mustangav.com

for 32" - 75"+ displays

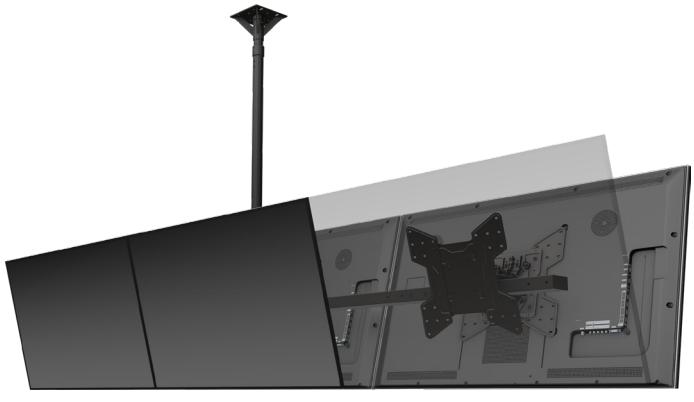

Attribute	Value
Max mounting pattern	VESA 800x600mm, Universal 800x672mm
Orientation	landscape or portrait
Roll (side to side)	+/- 3°
Tilt	+15°/-5°
Drop length	select from MPE-Series or MPEA-Series
Height adjustment	1" increments
Mounting interface	1.5" NPT thread compatible
Construction	aluminum/high-grade cold rolled steel
Product finish	scratch resistant epoxy powder coat
Color	black
Model number (per display configuration)	MPCM-M22V, MPCM-L44V, MPCM-X86U, MPCM-DM22V, MPCM-DL44V, MPCM-DX86U
Model number (single-pole kits)	MPCM-2KL44V, MPCM-2KX86U, MPCM-3KL44V, MPCM-D2KM44V, MPCM-D2KX86U, MPCM-D3KL44V
Warranty	10 years

The most flexible and infinitely expandable system for installing menu boards or any in-line single side or back to back configuration for displays 32"-75" and larger. For ease of quoting your customer, prices are based on the number of displays to be mounted. Hang 2,3,10 or more displays in-line. You are limited only by the structure to which the system is attached. Includes all of the necessary components and hardware needed to complete the installation, including the Ceiling Adapter(s). Just add the required drop length of fixed or adjustable column (MPE-Series or MPEA-Series) to complete the solution.

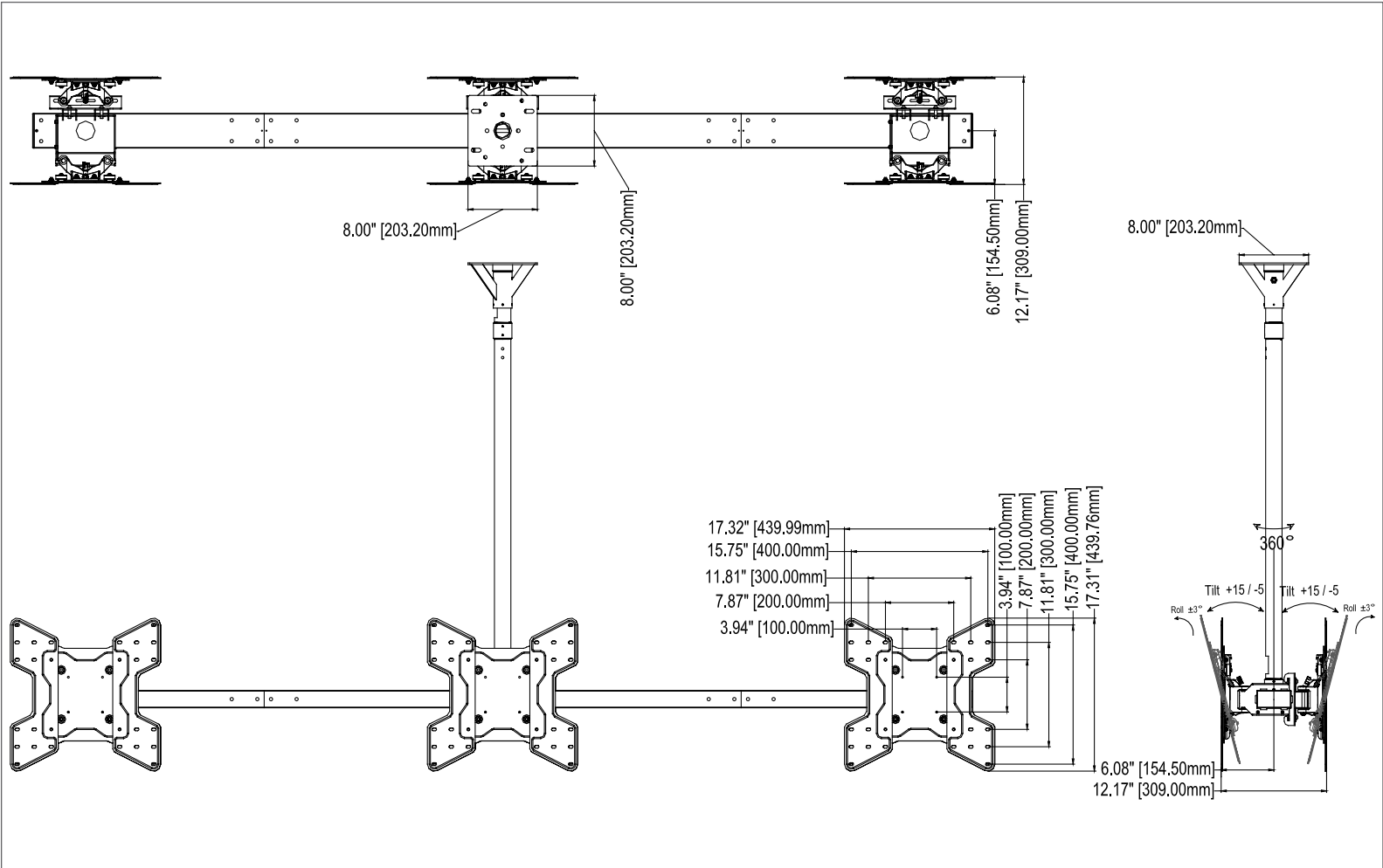

www.mustangav.com  
info@mustangav.com